

## СХЕМЫ ДЛЯ УСТАНОВКИ ПОДОГРЕВАТЕЛЯ ДВИГАТЕЛЯ- DEFA 411241.

На нижеуказанных рисунках показано расположение установочных отверстий в блоке двигателя, относительно моделей и марок транспортных средств.

**A**

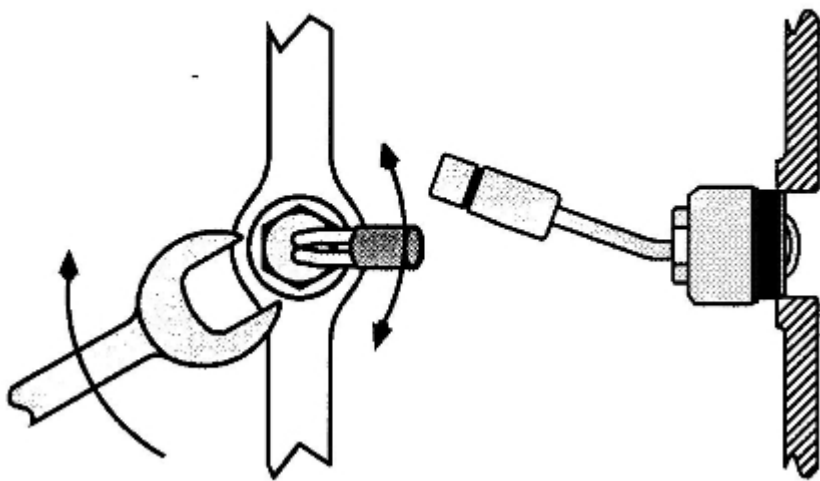

HONDA STREAM 2.0, CIVIC TUPE R 2.0, CR-V2.0 02>, ACORD 2.0, ACORD 2.4, SM-X, STEPVAGEN



HONDA JAZZ 1.4

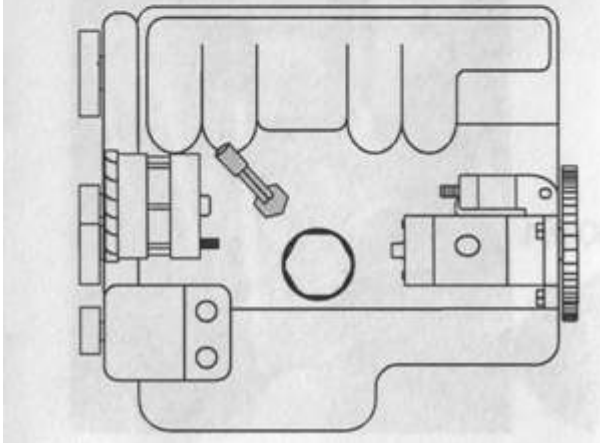
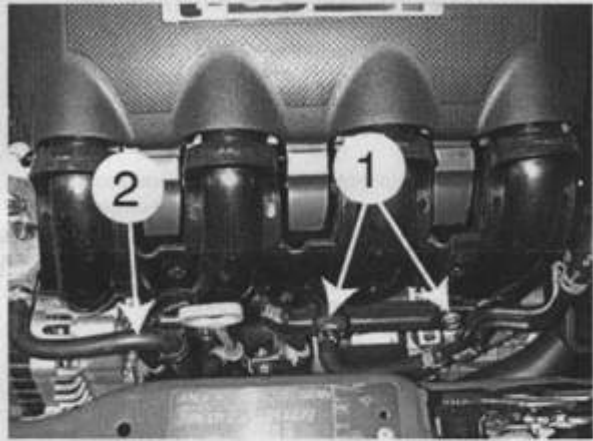

OPEL VECTRA C 3.2 GTS V6

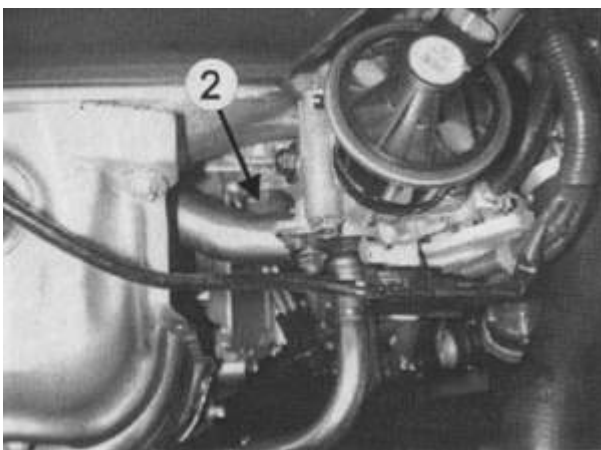
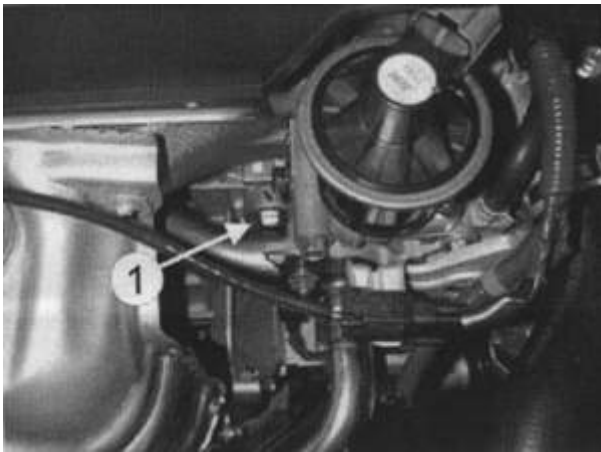
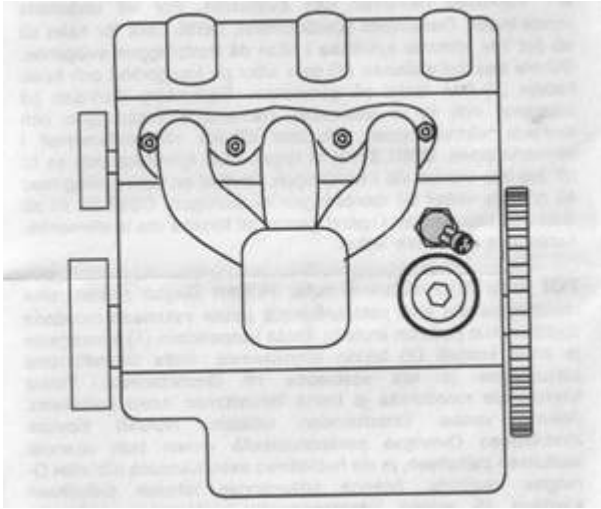

HONDA CIVIC 1,3 hybrid IMA

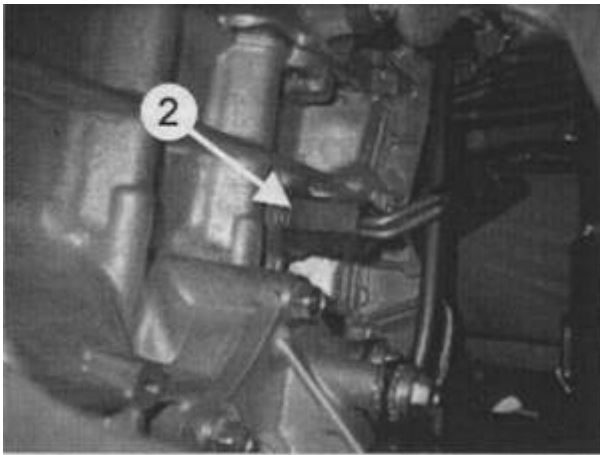
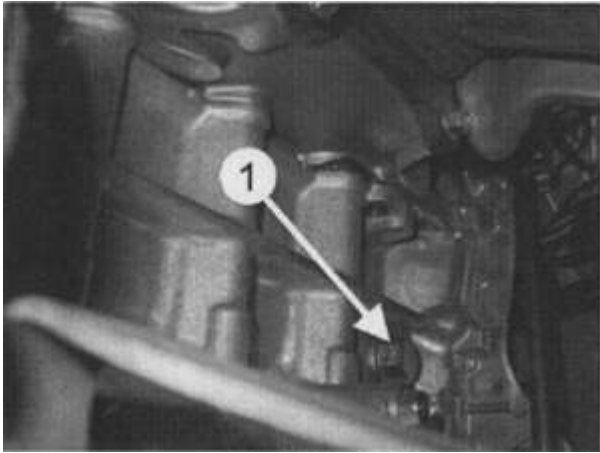

HONDA LEGEND 3.5 V6 (J35A8)

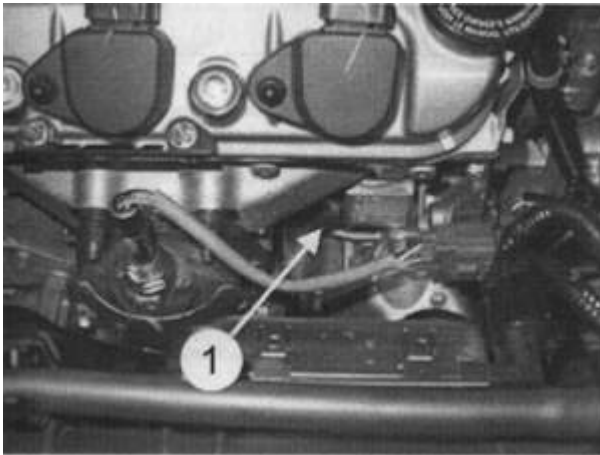

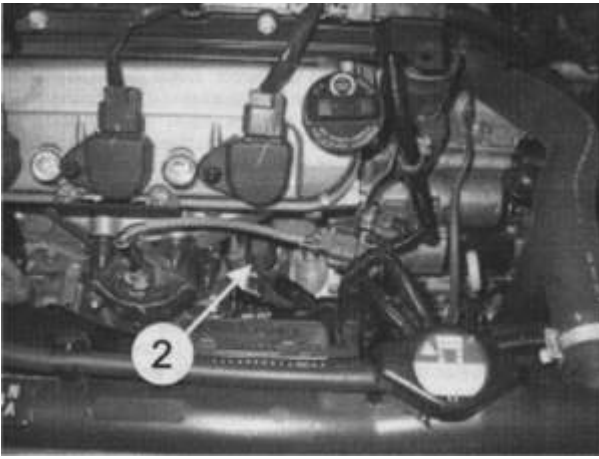

HONDA CIVIC 1.4 (L13A7)

